



# LINEAR LIGHT

性灯系  
列

No: 192, Nawala Road, Narahenpita, Colombo -05

Tel : 0777789276

E-mail : [serialinvestmentlanka@gmail.com](mailto:serialinvestmentlanka@gmail.com)



# LINEAR LIGHTING SYSTEM

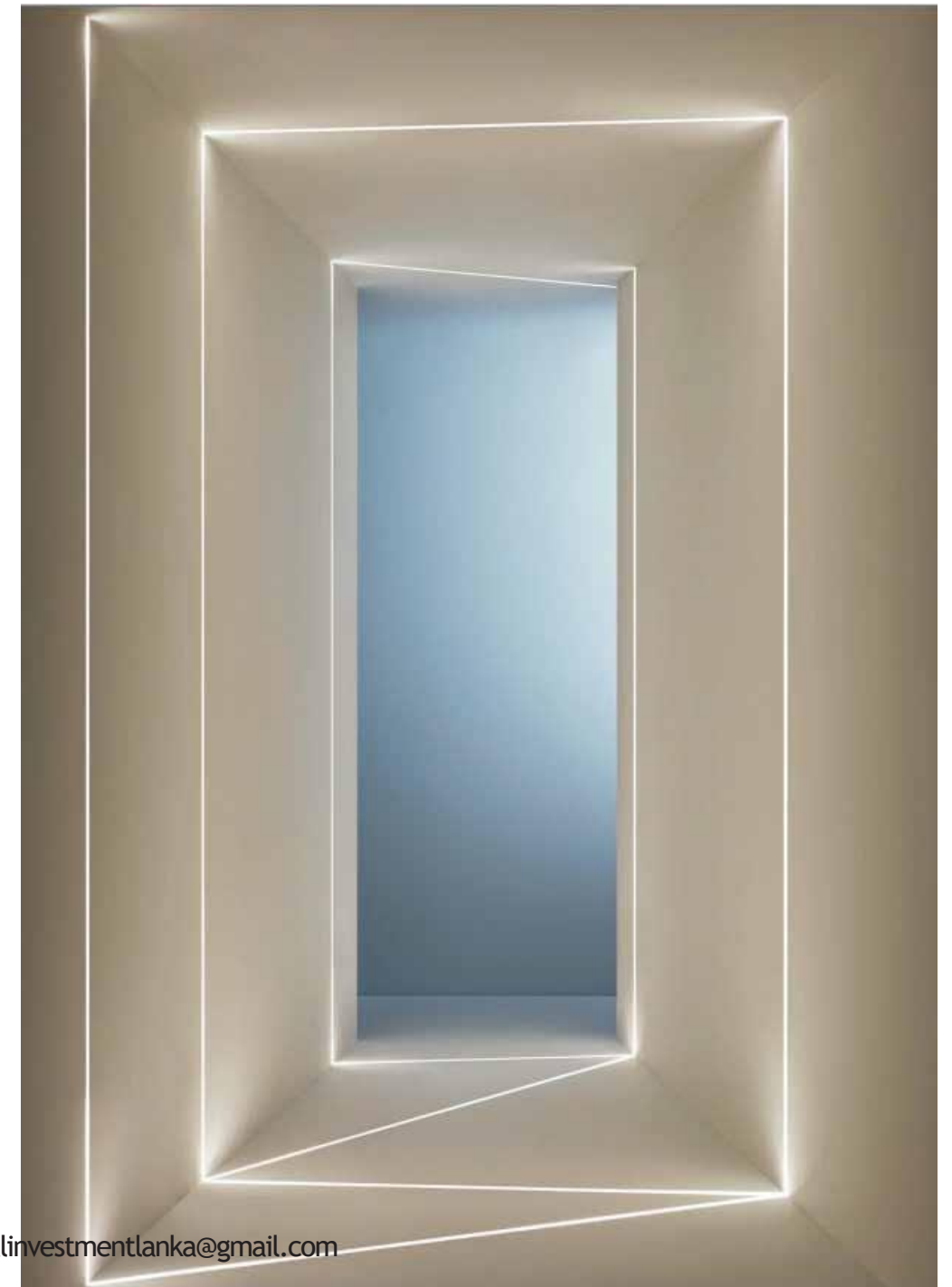







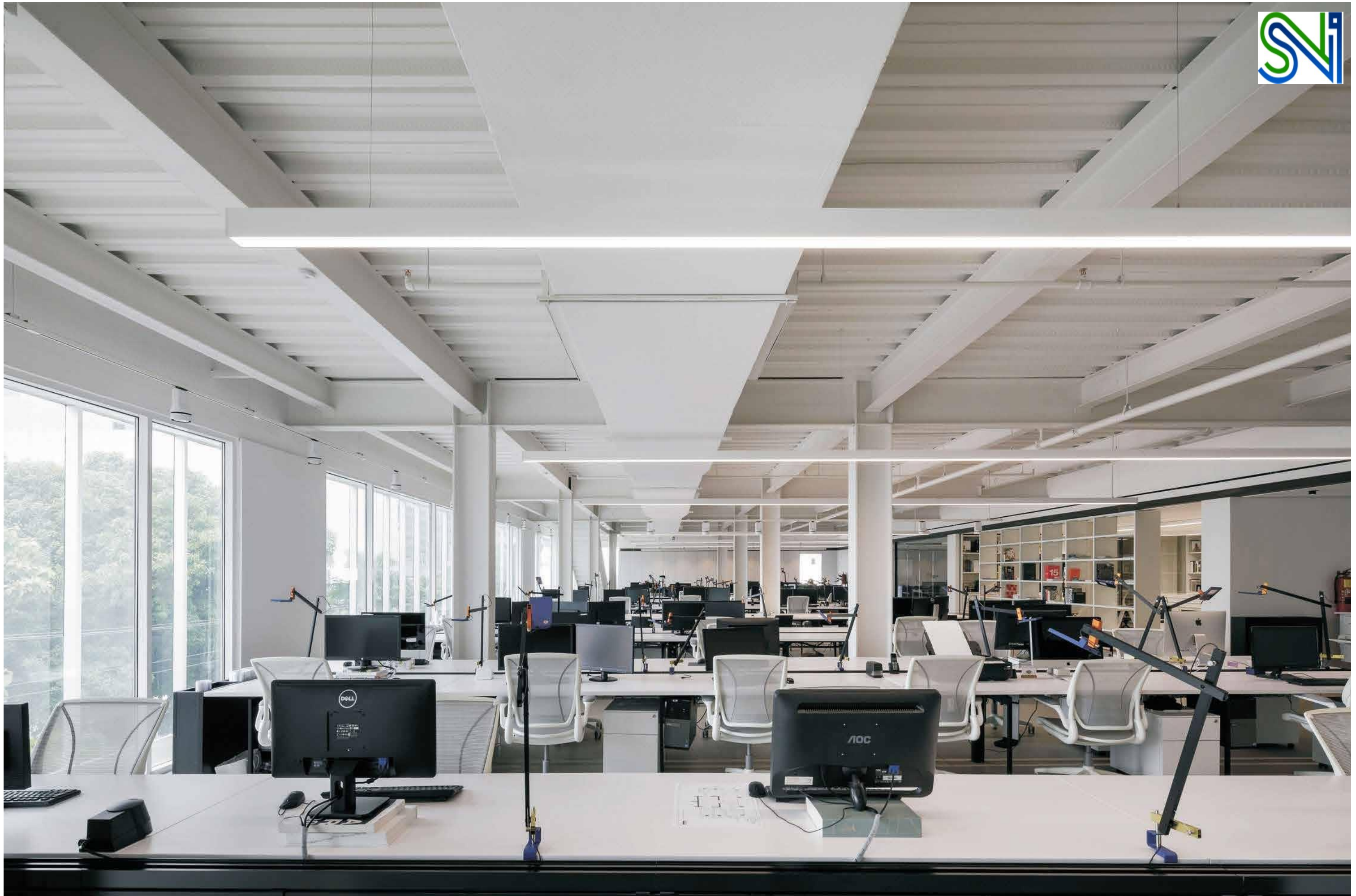





# DIY Your Style

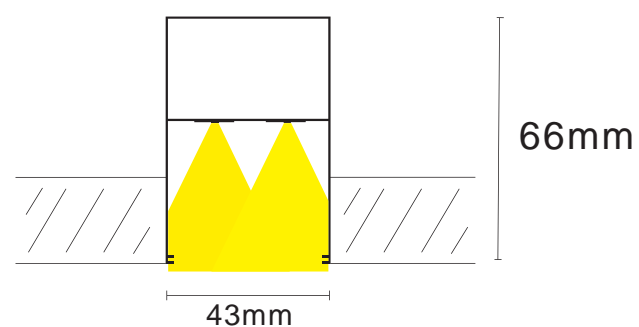

**918G**







型号 Order No.	功率 Power(W)	电压 Voltage(V)	显指 CRI	光束角 Beam Angle(°)	尺寸 SIZE(MM)
KDR-85052S	3W	100-240	85	15/30	30*30*H400
KDR-85052M	5W	100-240	85	15/30	50*50*H400
KDR-85052L	4.7W	100-240	85	15/30	60*60*H400



型号 Order No.	功率 Power(W)	电压 Voltage(V)	显指 CRI	光束角 Beam Angle(°)	尺寸 SIZE(MM)
KDR-85005R-3	3	100-240	85	10/15/24	Φ25*H520
KDR-85005R-5	5	100-240	85	10/15/24	Φ42*H525



型号 Order No.	功率 Power(W)	电压 Voltage(V)	显指 CRI	光束角 Beam Angle(°)	尺寸 SIZE(MM)
KDR-85029-1	6W	100-240	85	N/A	Φ75*H30



型号 Order No.	功率 Power(W)	电压 Voltage(V)	显指 CRI	光束角 Beam Angle(°)	尺寸 SIZE(MM)
KDR-22027S	3*2	100-240	85	N/A	62*26*H205
KDR-22027M	6*2	100-240	85	N/A	116*26*H135



型号 Order No.	功率 Power(W)	电压 Voltage(V)	显指 CRI	光束角 Beam Angle(°)	尺寸 SIZE(MM)
KDR-22028S	3	100-240	85	15/25	Φ28*H100
KDR-22028M	5	100-240	85	15/25	Φ40*H110



型号 Order No.	功率 Power(W)	电压 Voltage(V)	显指 CRI	光束角 Beam Angle(°)	尺寸 SIZE(MM)
KDR-22029	5	100-240	85	15/25	Φ60*H110





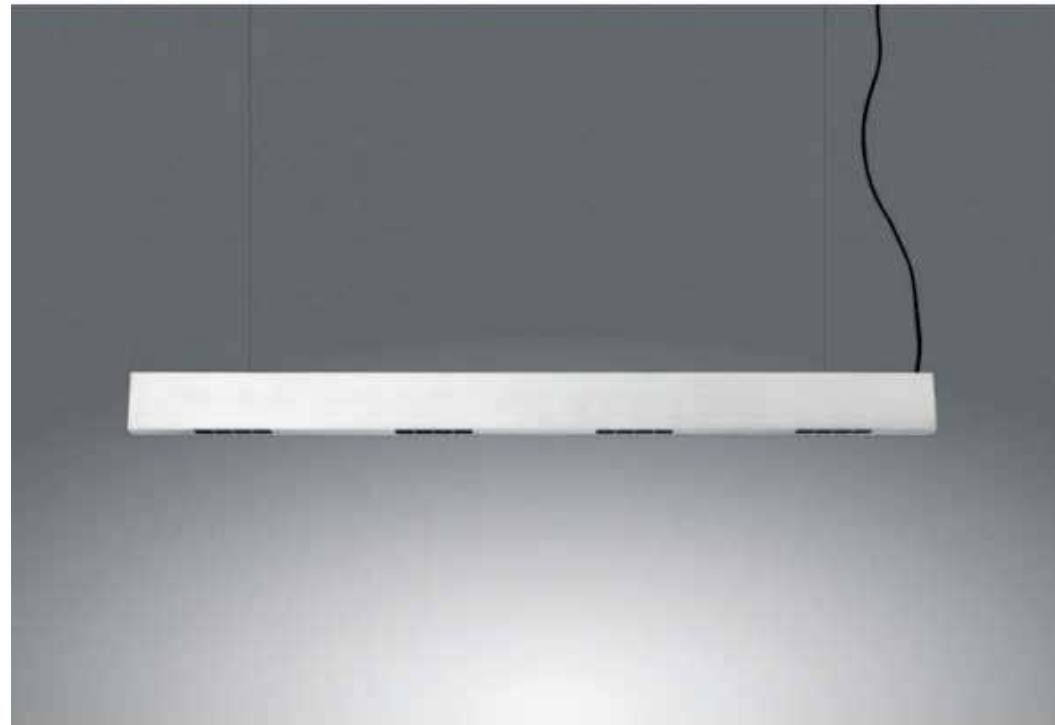

- 光效:85Lm/W
- Efficiency:85Lm/W
- 主体使用纯铝
- Body of aluminum

型号 Order No.	功率 Power(W)	电压 Voltage(V)	显指 CRI	光束角 Beam Angle(°)	尺寸 SIZE(MM)
KDR-OL918G	15*1W	100-240	85	120	L1180*W43*H66





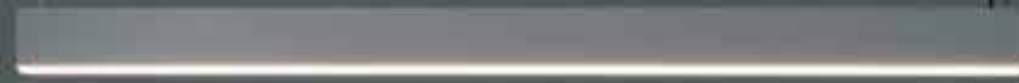

**Flexible Installation**

**Surface Mounted, Suspended, and Recessed**





- 光效:80Lm/W
- Efficiency80Lm/W
- 主体使用纯铝
- Body of aluminum

型号 OrderNo.	功率 Power(W)	电压 Voltage(V)	显指 CRI	光束角 BeamAngle(°)	尺寸 SIZE(MM)
KDR-710	28	100-240	75	120	L1000*W33*H85
KDR-918S	28	100-240	75	120	L1200*W43*H66

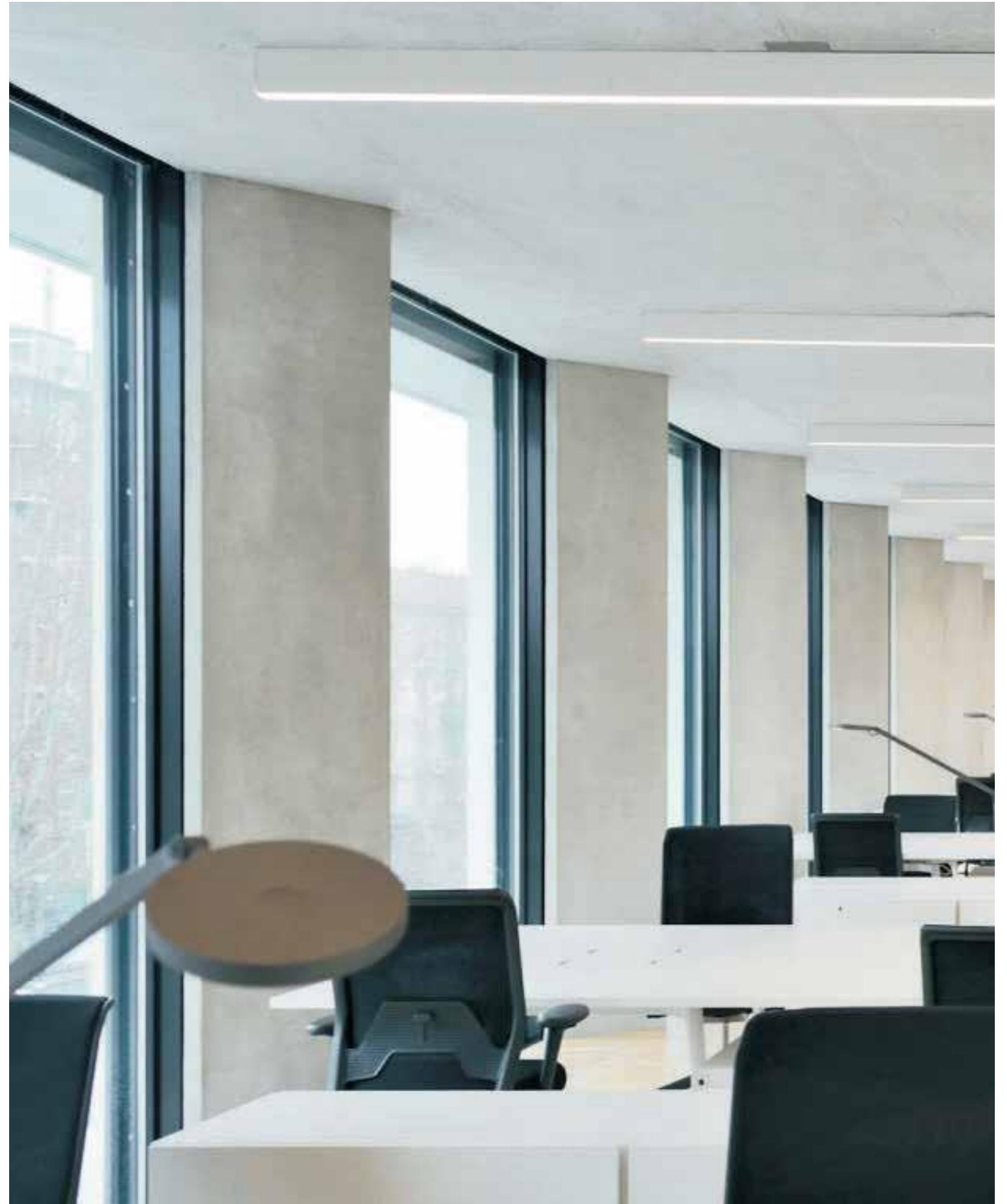



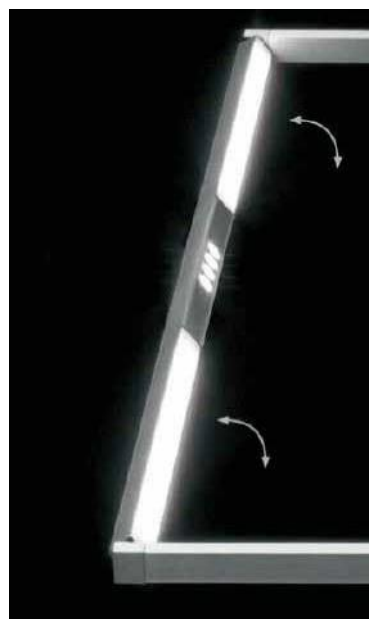

Adjustable

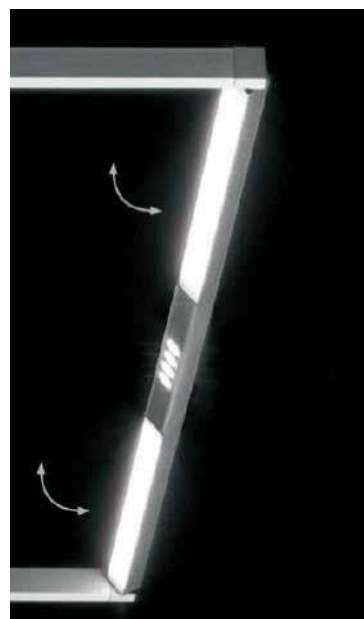

- 光效:80Lm/W
- Efficiency:80Lm/W
- 主体使用纯铝
- Body of aluminum

型号 OrderNo.	功率 Power(W)	电压 Voltage(V)	显指 CRI	光束角 Beam Angle(°)	尺寸 SIZE(MM)
KDR-85056	78W	100-240	75	120	L2000*W1000*H25

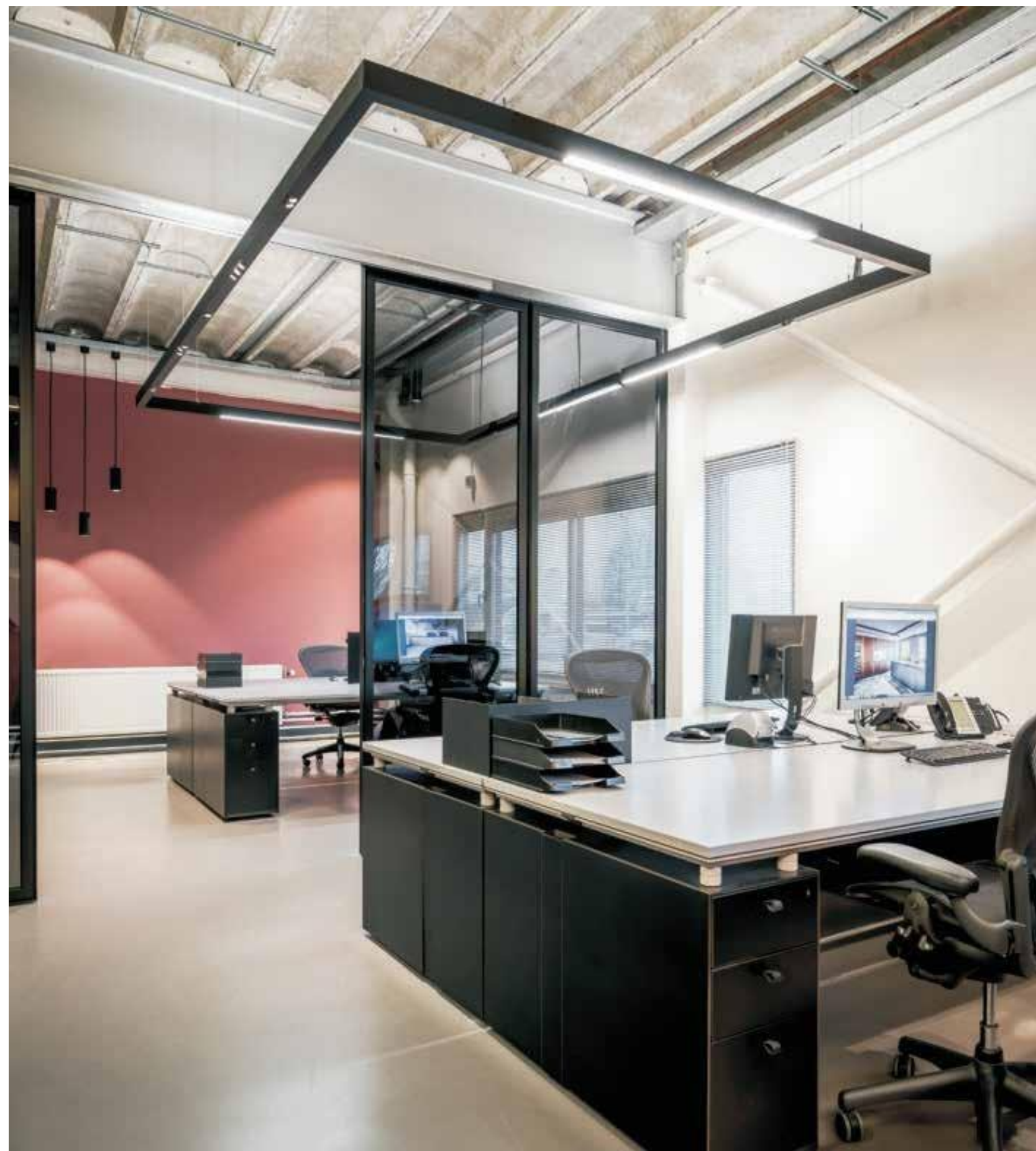



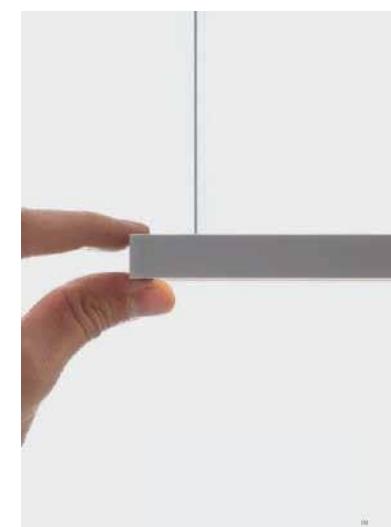
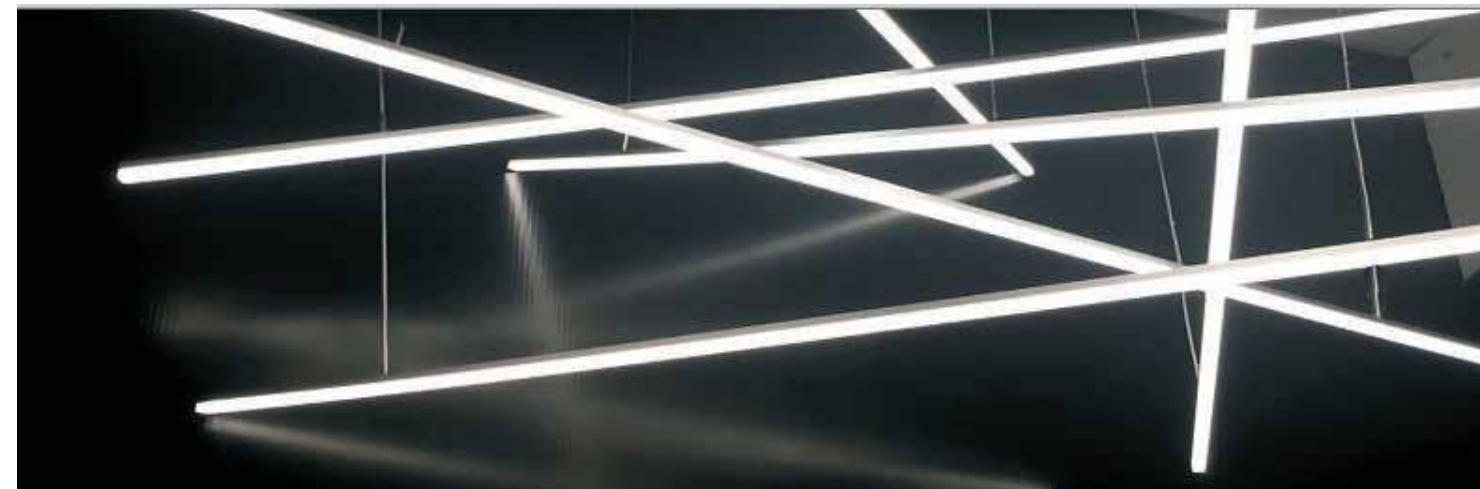

# LINE LIGHT

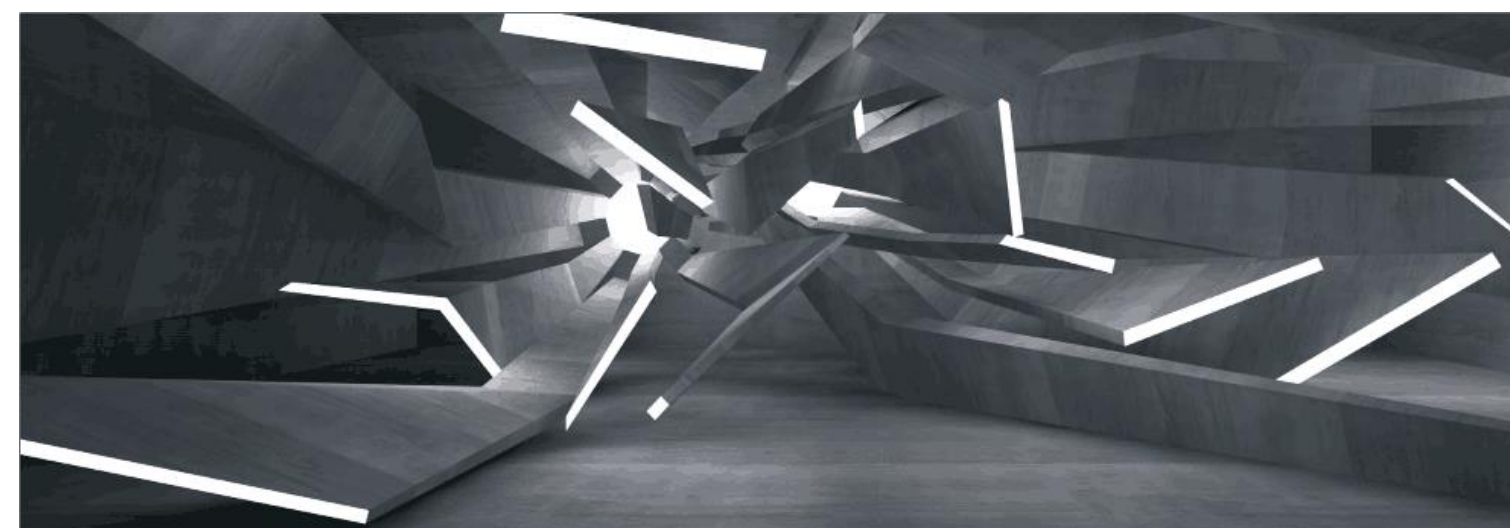





- 光效:80Lm/W
- Efficiency:80Lm/W
- 主体使用纯铝
- Body of aluminum

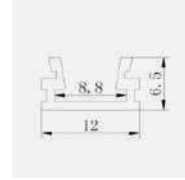

型号 Order No.	功率 Power(W)	电压 Voltage(V)	显指 CRI	光束角 Beam Angle(°)	色温 SIZE(MM)
KDR-627	14W/M	12V	75	120	L1005*W12*H6.5



- 光效:80Lm/W
- Efficiency:80Lm/W
- 主体使用纯铝
- Body of aluminum

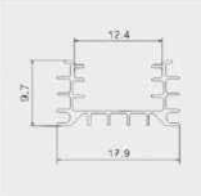

型号 Order No.	功率 Power(W)	电压 Voltage(V)	显指 CRI	光束角 Beam Angle(°)	色温 SIZE(MM)
KDR-507	14W/M	12V	75	120	L1005*W17.9*H9.7



- 光效:80Lm/W
- Efficiency:80Lm/W
- 主体使用纯铝
- Body of aluminum

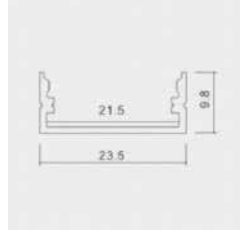
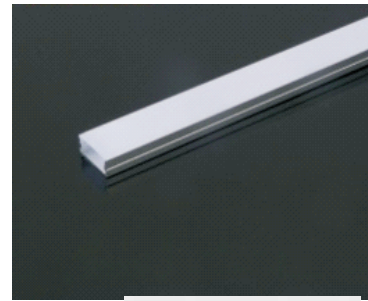

型号 Order No.	功率 Power(W)	电压 Voltage(V)	显指 CRI	光束角 Beam Angle(°)	色温 SIZE(MM)
KDR-617	14W/M	12V	75	120	L1005*W23.5*H10



- 光效:80Lm/W
- Efficiency:80Lm/W
- 主体使用纯铝
- Body of aluminum

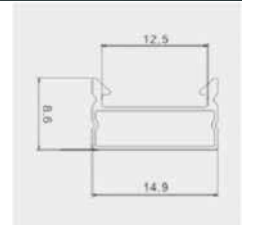

型号 Order No.	功率 Power(W)	电压 Voltage(V)	显指 CRI	光束角 Beam Angle(°)	色温 SIZE(MM)
KDR-502	14W/M	12V	75	120	L1005*W15*H8.7





- 光效:80Lm/W
- Efficiency:80Lm/W
- 主体使用纯铝
- Body of aluminum

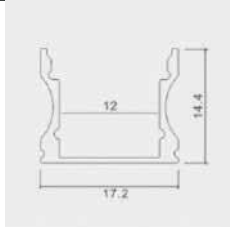
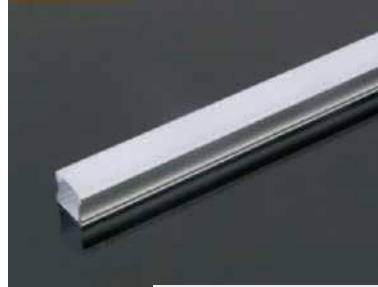

型号 Order No.	功率 Power(W)	电压 Voltage(V)	显指 CRI	光束角 Beam Angle(°)	色温 SIZE(MM)
KDR-613	14W/M	12V	75	120	L1005*W17.2*H14.4



- 光效:80Lm/W
- Efficiency:80Lm/W
- 主体使用纯铝
- Body of aluminum

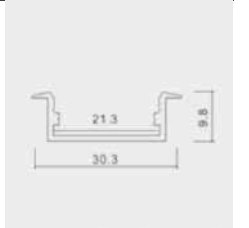
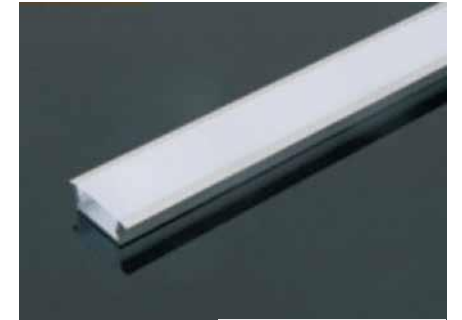

型号 Order No.	功率 Power(W)	电压 Voltage(V)	显指 CRI	光束角 Beam Angle(°)	色温 SIZE(MM)
KDR-619	14W/M	12V	75	120	L1005*W30*H10



- 光效:80Lm/W
- Efficiency:80Lm/W
- 主体使用纯铝
- Body of aluminum

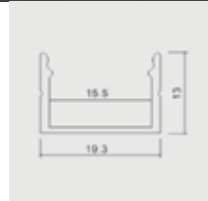
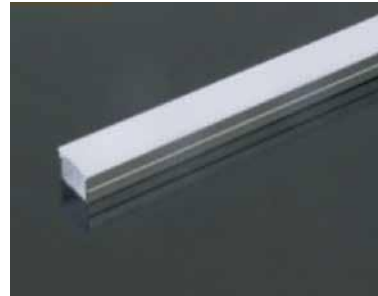

型号 Order No.	功率 Power(W)	电压 Voltage(V)	显指 CRI	光束角 Beam Angle(°)	色温 SIZE(MM)
KDR-616	14W/M	12V	75	120	L1005*W19.3*H13



- 光效:80Lm/W
- Efficiency:80Lm/W
- 主体使用纯铝
- Body of aluminum

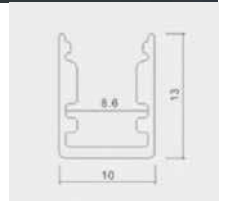
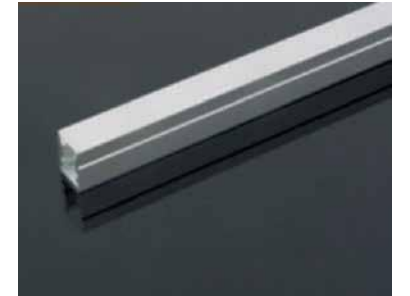

型号 Order No.	功率 Power(W)	电压 Voltage(V)	显指 CRI	光束角 Beam Angle(°)	色温 SIZE(MM)
KDR-624	14W/M	12V	75	120	L1005*W10*H13







-光效:80Lm/W  
 -Efficiency:80Lm/W  
 -主体使用纯铝  
 -Body of aluminum

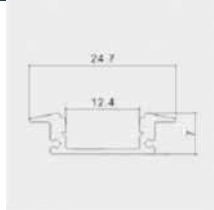

型号 Order No.	功率 Power(W)	电压 Voltage(V)	显指 CRI	光束角 Beam Angle(°)	色温 SIZE(MM)
KDR-508	14W/M	12V	75	120	L1005*W24.7*H7



-光效:80Lm/W  
 -Efficiency:80Lm/W  
 -主体使用纯铝  
 -Body of aluminum

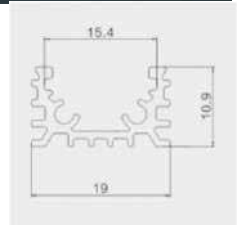

型号 Order No.	功率 Power(W)	电压 Voltage(V)	显指 CRI	光束角 Beam Angle(°)	色温 SIZE(MM)
KDR-519	14W/M	12V	75	120	L1005*W19*H11



-光效:80Lm/W  
 -Efficiency:80Lm/W  
 -主体使用纯铝  
 -Body of aluminum

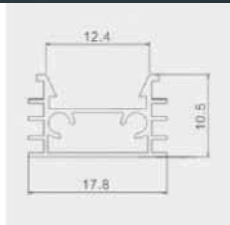

型号 Order No.	功率 Power(W)	电压 Voltage(V)	显指 CRI	光束角 Beam Angle(°)	色温 SIZE(MM)
KDR-518	14W/M	12V	75	120	L1005*W13.2*H7



-光效:80Lm/W  
 -Efficiency:80Lm/W  
 -主体使用纯铝  
 -Body of aluminum

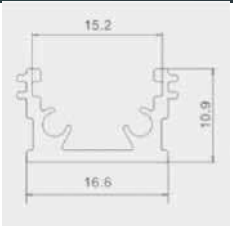

型号 Order No.	功率 Power(W)	电压 Voltage(V)	显指 CRI	光束角 Beam Angle(°)	色温 SIZE(MM)
KDR-520	14W/M	12V	75	120	L1005*W16.8*H11





CE RoHS IP20

- 光效:80Lm/W
- Efficiency:80Lm/W
- 主体使用纯铝
- Body of aluminum

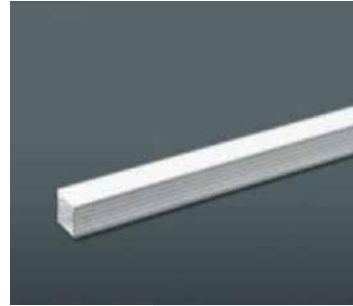

型号 Order No.	功率 Power(W)	电压 Voltage(V)	显指 CRI	光束角 Beam Angle(°)	色温 SIZE(MM)
KDR-524	14W/M	12V	75	120	L1005*W11.7*H7.1



CE RoHS IP20

- 光效:80Lm/W
- Efficiency:80Lm/W
- 主体使用纯铝
- Body of aluminum

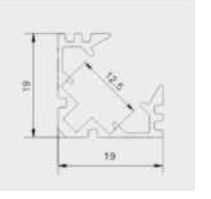

型号 Order No.	功率 Power(W)	电压 Voltage(V)	显指 CRI	光束角 Beam Angle(°)	色温 SIZE(MM)
KDR-604	14W/M	12V	75	120	L1005*W19*H19



CE RoHS IP20

- 光效:80Lm/W
- Efficiency:80Lm/W
- 主体使用纯铝
- Body of aluminum

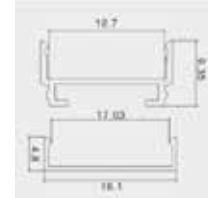

型号 Order No.	功率 Power(W)	电压 Voltage(V)	显指 CRI	光束角 Beam Angle(°)	色温 SIZE(MM)
KDR-602	14W/M	12V	75	120	L1005*W19.3*H20



CE RoHS IP20

- 光效:80Lm/W
- Efficiency:80Lm/W
- 主体使用纯铝
- Body of aluminum

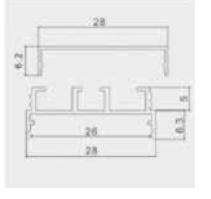

型号 Order No.	功率 Power(W)	电压 Voltage(V)	显指 CRI	光束角 Beam Angle(°)	色温 SIZE(MM)
KDR-603	14W/M	12V	75	120	L1005*W28.2*H24





- 光效:80Lm/W
- Efficiency:80Lm/W
- 主体使用纯铝
- Body of aluminum

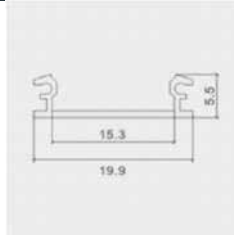

型号 Order No.	功率 Power(W)	电压 Voltage(V)	显指 CRI	光束角 Beam Angle(°)	色温 SIZE(MM)
KDR-609	14W/M	12V	75	120	L1005*W20*H6



- 采用SMD光源
- Surface mounted with SMD LED
- 宽光束角
- Wide Beam Angle
- 光效:80Lm/W
- Efficiency:80Lm/W
- 主体使用纯铝
- Body of aluminium
- 配备LED电子驱动器
- Luminaires are equipped with electronic driver

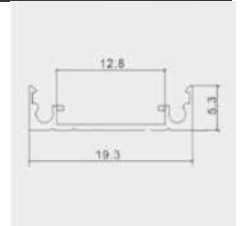
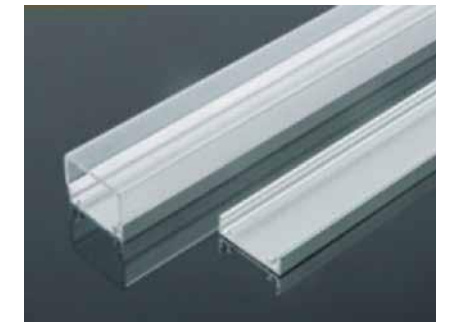

型号 Order No.	功率 Power(W)	电压 Voltage(V)	显指 CRI	光束角 Beam Angle(°)	色温 SIZE(MM)
KDR-611	14W/M	12V	75	120	L1005*W20*H15



- 光效:80Lm/W
- Efficiency:80Lm/W
- 主体使用纯铝
- Body of aluminum

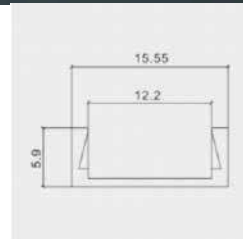
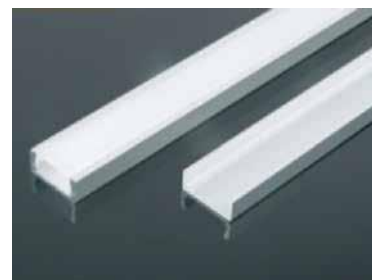

型号 Order No.	功率 Power(W)	电压 Voltage(V)	显指 CRI	光束角 Beam Angle(°)	色温 SIZE(MM)
KDR-610	14W/M	12V	75	120	L1005*W15.8*H6.7



- 光效:80Lm/W
- Efficiency:80Lm/W
- 主体使用纯铝
- Body of aluminum

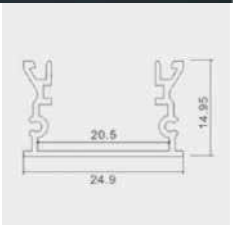

型号 Order No.	功率 Power(W)	电压 Voltage(V)	显指 CRI	光束角 Beam Angle(°)	色温 SIZE(MM)
KDR-612	14W/M	12V	75	120	L1005*W25*H15







-光效:80Lm/W  
 -Efficiency:80Lm/W  
 -主体使用纯铝  
 -Body of aluminum

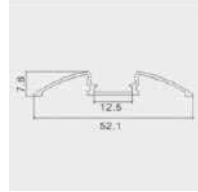

型号 Order No.	功率 Power(W)	电压 Voltage(V)	显指 CRI	光束角 Beam Angle(°)	色温 SIZE(MM)
KDR-608	14W/M	12V	75	120	L1005*W52*H7.8



-光效:80Lm/W  
 -Efficiency:80Lm/W  
 -主体使用纯铝  
 -Body of aluminum

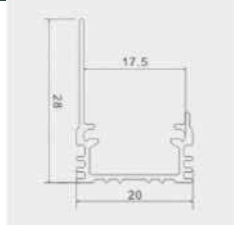

型号 Order No.	功率 Power(W)	电压 Voltage(V)	显指 CRI	光束角 Beam Angle(°)	色温 SIZE(MM)
KDR-501	14W/M	12V	75	120	L1005*W20*H28



-光效:80Lm/W  
 -Efficiency:80Lm/W  
 -主体使用纯铝  
 -Body of aluminum



型号 Order No.	功率 Power(W)	电压 Voltage(V)	显指 CRI	光束角 Beam Angle(°)	色温 SIZE(MM)
KDR-801	14W/M	12V	75	120	L1005*W66.5*H27



-光效:80Lm/W  
 -Efficiency:80Lm/W  
 -主体使用纯铝  
 -Body of aluminum

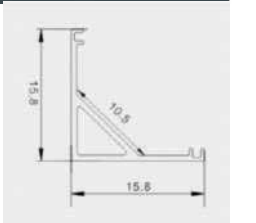

型号 Order No.	功率 Power(W)	电压 Voltage(V)	显指 CRI	光束角 Beam Angle(°)	色温 SIZE(MM)
KDR-601	14W/M	12V	75	120	L1005*W16*H16





CE RoHS IP20

- 光效:80Lm/W
- Efficiency:80Lm/W
- 主体使用纯铝
- Body of aluminum

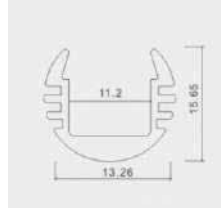

型号 Order No.	功率 Power(W)	电压 Voltage(V)	显指 CRI	光束角 Beam Angle(°)	色温 SIZE(MM)
KDR-615	14W/M	12V	75	120	L1005*W13.26*H15.65

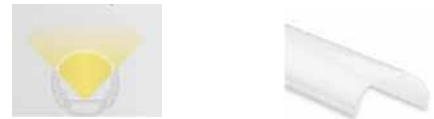

CE RoHS IP20

- 光效:80Lm/W
- Efficiency:80Lm/W
- 主体使用纯铝
- Body of aluminum



型号 Order No.	功率 Power(W)	电压 Voltage(V)	显指 CRI	光束角 Beam Angle(°)	色温 SIZE(MM)
KDR-631	14W/M	12V	75	120	L1005*W19*H27



CE RoHS IP20

- 光效:80Lm/W
- Efficiency:80Lm/W
- 主体使用纯铝
- Body of aluminum

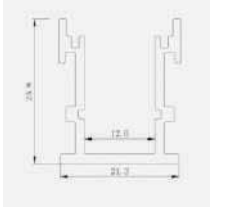
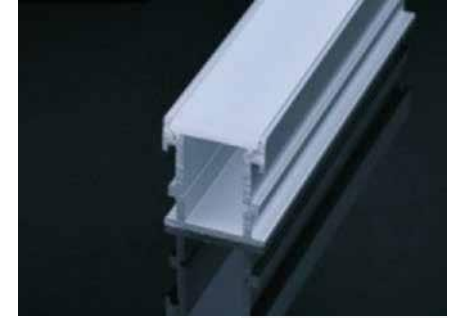

型号 Order No.	功率 Power(W)	电压 Voltage(V)	显指 CRI	光束角 Beam Angle(°)	色温 SIZE(MM)
KDR-632	14W/M	12V	75	120	L1005*W21*H26



CE RoHS IP20

- 光效:80Lm/W
- Efficiency:80Lm/W
- 主体使用纯铝
- Body of aluminum

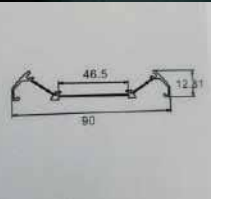

型号 Order No.	功率 Power(W)	电压 Voltage(V)	显指 CRI	光束角 Beam Angle(°)	色温 SIZE(MM)
KDR-701D	14W/M	12V	75	120	L1005*W91*H13

